

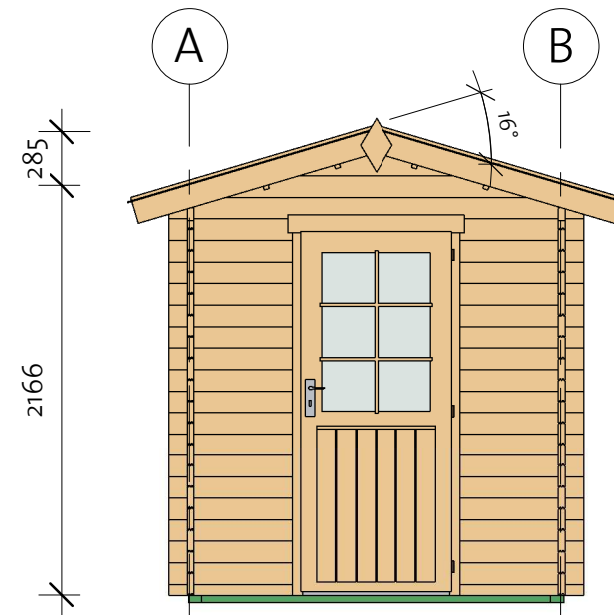

Sølvi 34 (200x240)

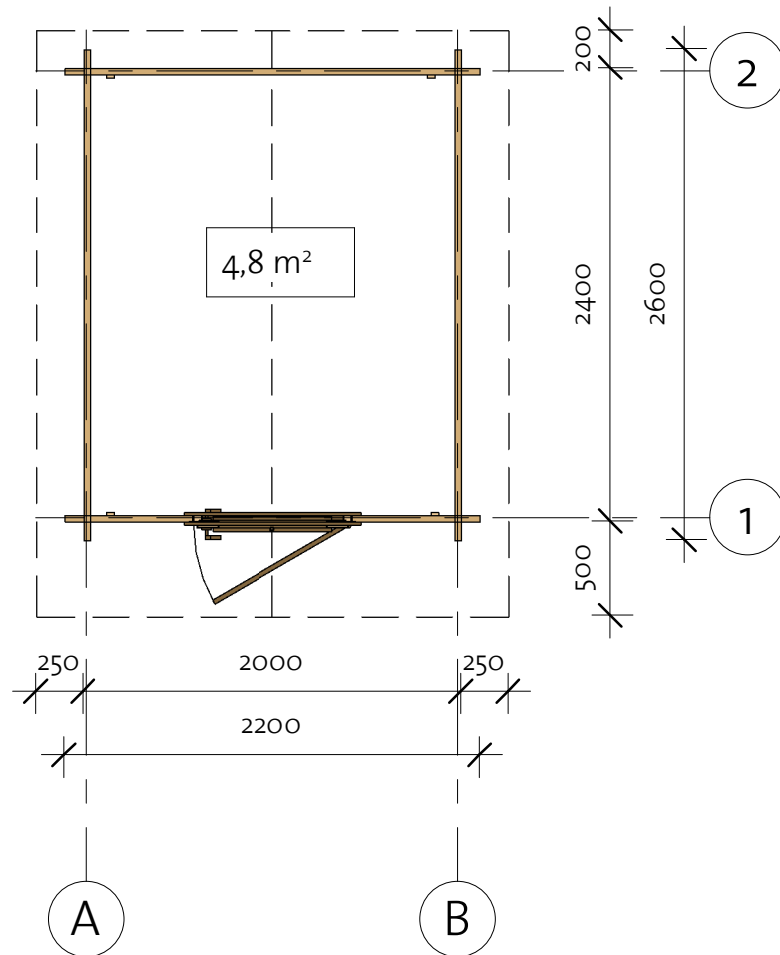
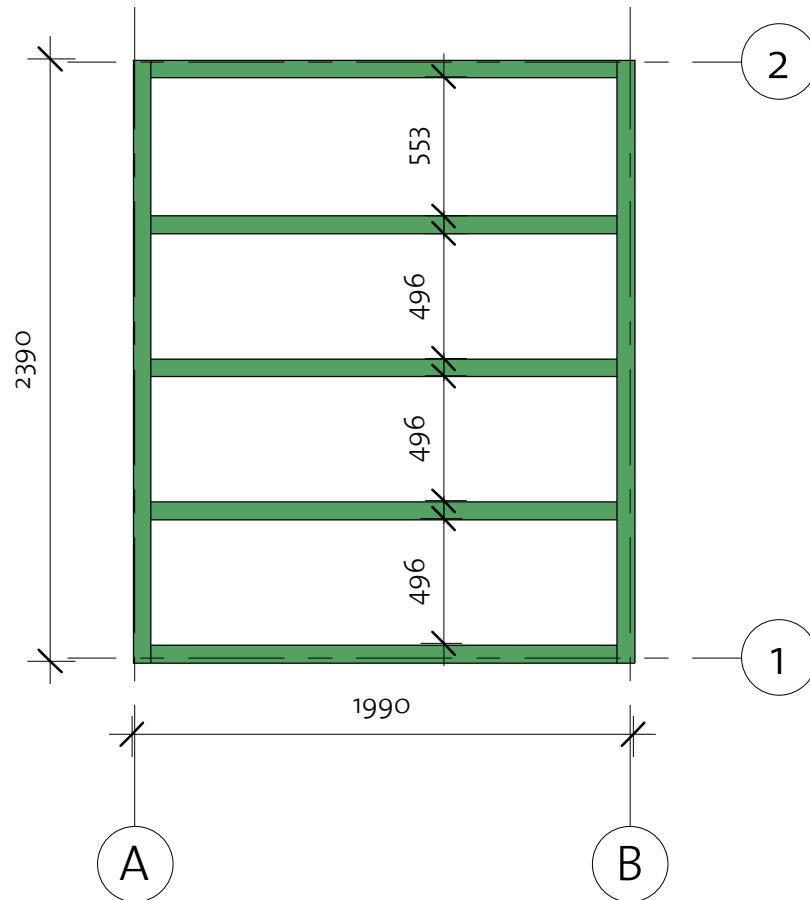

Sølvi 34 (200x240)

Foundation



Impregnated foundation beams				
Mark	Type	Profile	Count	Length
IFB1	IFB 70x40		5	1850
IFB2	IFB 70x40		2	2390

Sølvi 34 (200x240)

Floor Plan

① Baseboard

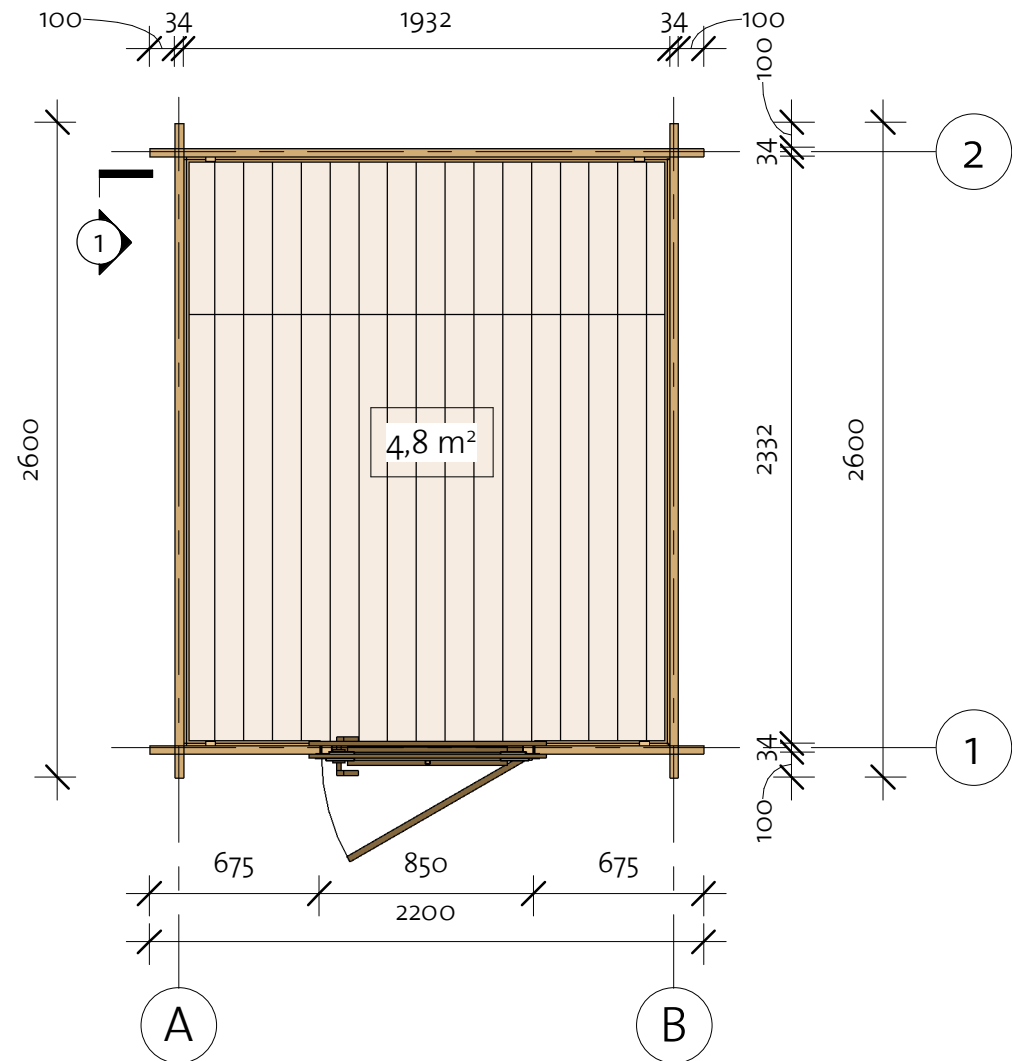
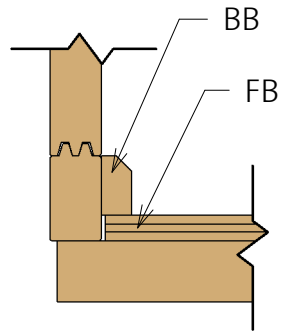

Floor Schedule

Mark	Type	Profile	Count	Length
------	------	---------	-------	--------

FB1	FB 17x114		18	1700
FB2	FB 17x114		18	626

BB1	BB 20x40		2	2000
BB2	BB 20x40		2	2400

92110071_211007

Sølvi 34 (200x240)

Wall 1

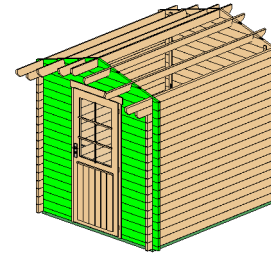

Wall 1			
Mark	Profile	Count	Cut Length

1BL-1	34X57	2	675
1LG-1 *	34X114	1	776
1LG-2 *	34X114	1	1547
1LG-3 *	34X114	1	2200
1LG-4	34X114	1	2200
1LG-5	34X114	34	675

*Gable-delivered premounted

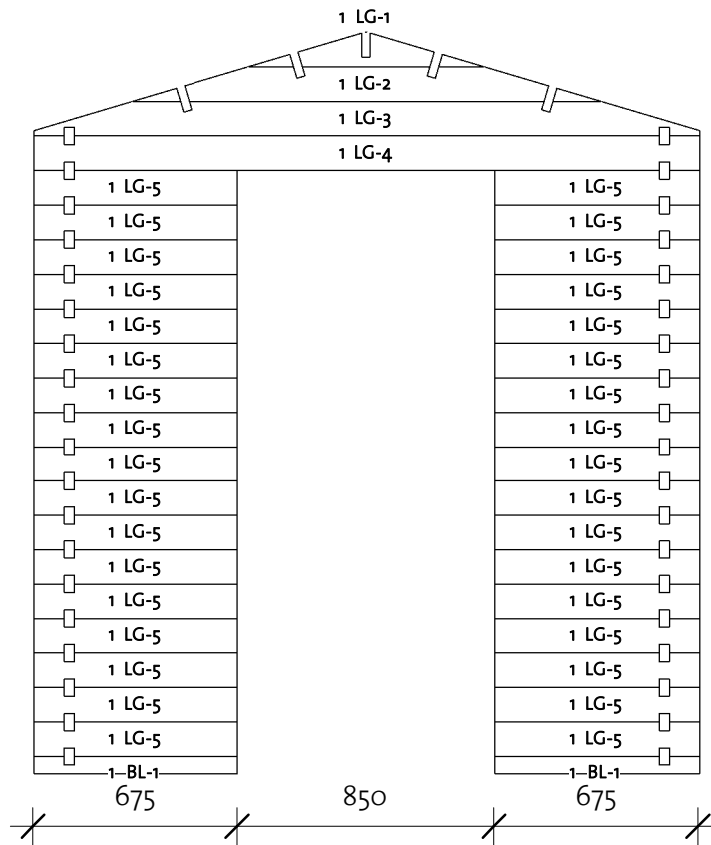

Log Profile Wall 1	
Profile	Profile

34X57	
34X114	

Sølvi 34 (200x240)

Wall B

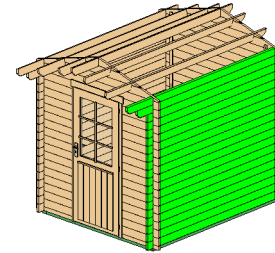

Wall B			
Mark	Profile	Count	Cut Length

BLG-1	34X114	17	2600
BLG-2	34X114	1	2800
BTL-1	34X114	1	3100

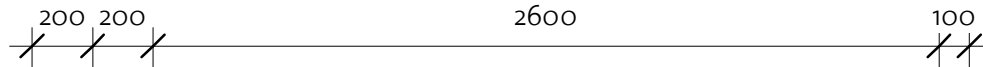
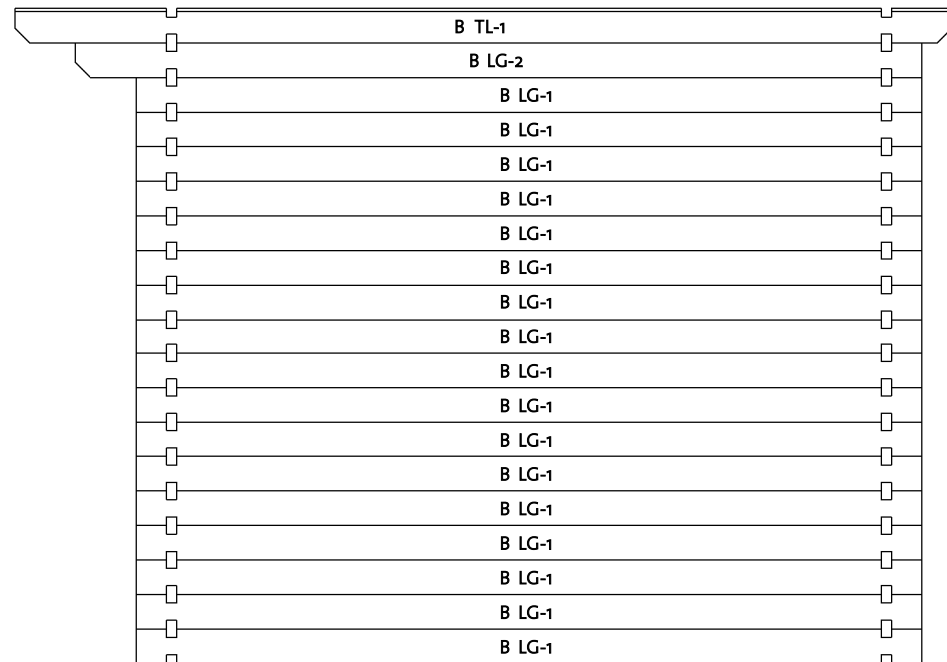

92110071_211007



Log Profile Wall B	
Profile	Profile

34X114	
34X114	

Sølvi 34 (200x240)

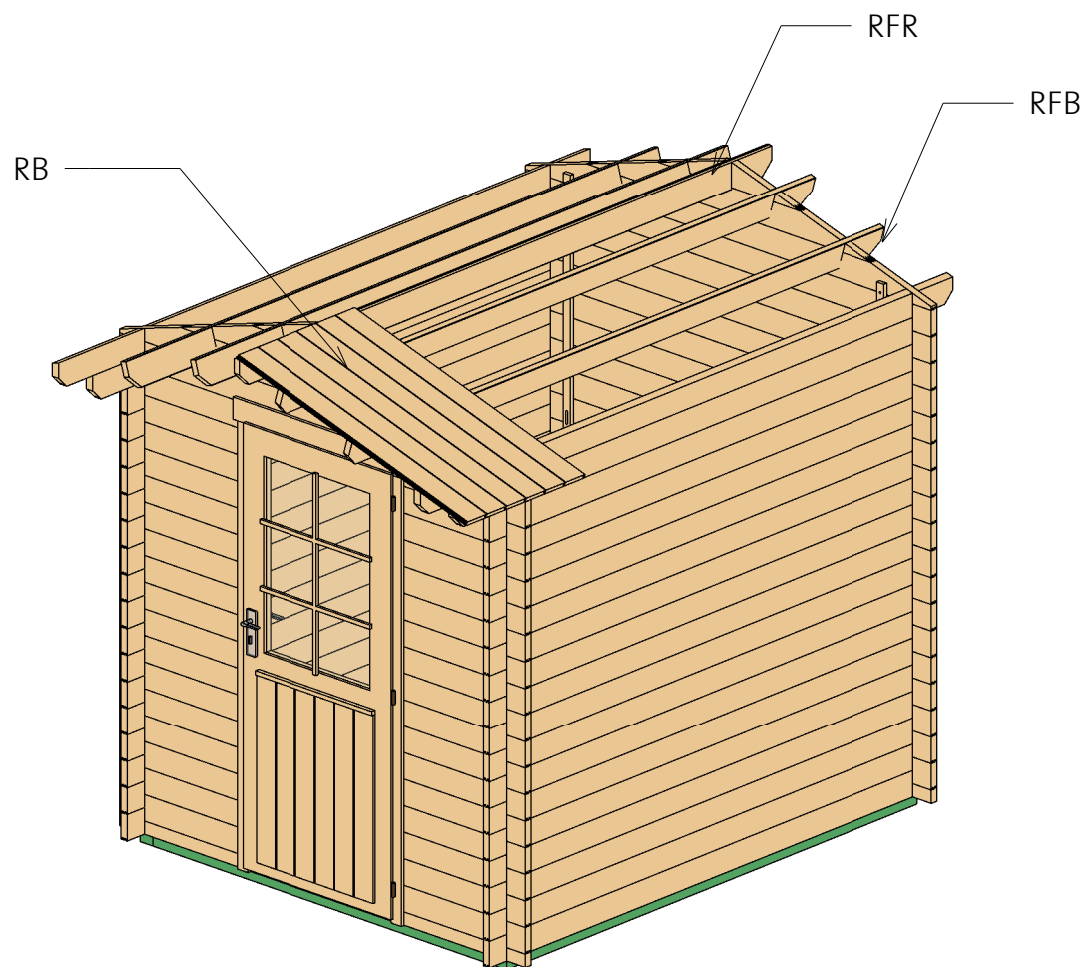
Roof 1



Roof				
Mark	Type	Profile	Count	Length
RFR	Ridge 28x123		1	3100
RFB	Beam 28x123		4	3100
RB	17x114		56	1299

Sølvi 34 (200x240)

Roof 2

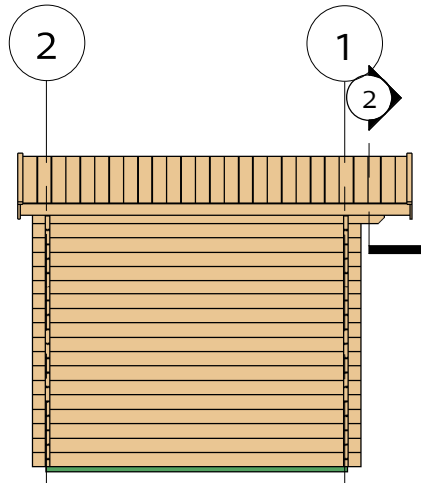

② Fascia

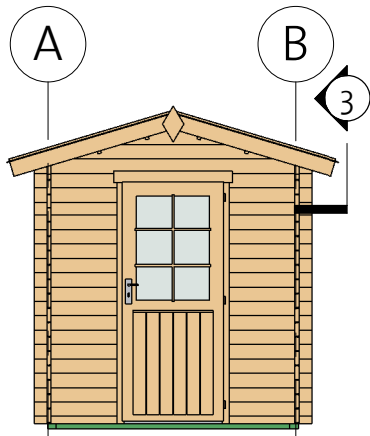
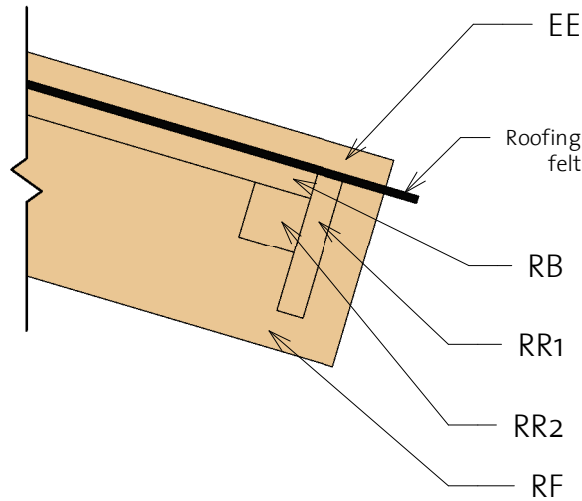

③ Roof Reinforcement

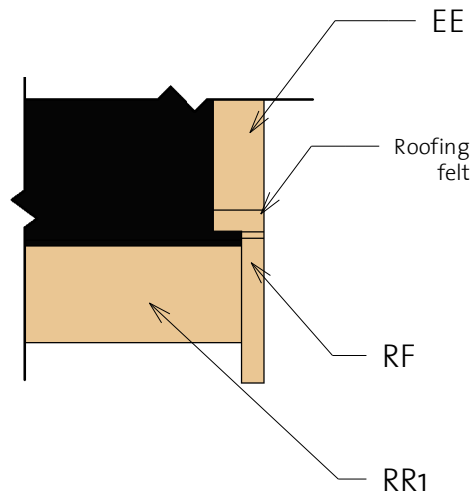

Fascia Schedule

Mark	Type	Profile	Count	Length
EE	Eave Edging 18x40		4	1350
RF	Roof Fascia 18x120		4	1350
RR1	Roof reinforce ment 18x95		2	3100
RR2	Roof reinforce ment 38x38		2	3100

Sølvi 34 (200x240)

Extras



Door Schedule				
Model	Type	Width	Height	Count
B34D1R	Basic 34 door 1 right	840	1955	1

Type	Count	Length
------	-------	--------

Windboard 18x40	4	2200
-----------------	---	------

Romb	2
------	---





Fasteners/Extras		
Name	Type	Count

Hitblock	300-400 mm	
Bolts	M8 x 70	12
Screws	5,0 x 70	20
Screws	6,0 x 140	25
Nails	1,4 x 40	25
Screws	4,0 x 40	70
Screws	4,0 x 50	360





Sølvi 34 (200x240)

List of all items 1



Impregnated foundation beams

Mark	Type	Profile	Count	Length
IFB1	IFB 70x40		5	1850
IFB2	IFB 70x40		2	2390



Fascia Schedule

Mark	Type	Profile	Count	Length
EE	Eave Edging 18x40		4	1350
RF	Roof Fascia 18x120		4	1350
RR1	Roof reinforce ment 18x95		2	3100
RR2	Roof reinforce ment 38x38		2	3100

Floor Schedule

Mark	Type	Profile	Count	Length
FB1	FB 17x114		18	1700
FB2	FB 17x114		18	626
BB1	BB 20x40		2	2000
BB2	BB 20x40		2	2400

Roof

Mark	Type	Profile	Count	Length
RFR	Ridge 28x123		1	3100
RFB	Beam 28x123		4	3100
RB	17x114		56	1299

Sølvi 34 (200x240)

List of all items 2



Wall 1			
Mark	Profile	Count	Cut Length

1BL-1	34X57	2	675
1LG-1 *	34X114	1	776
1LG-2 *	34X114	1	1547
1LG-3 *	34X114	1	2200
1LG-4	34X114	1	2200
1LG-5	34X114	34	675

Wall A			
Mark	Profile	Count	Cut Length

ALG-1	34X114	17	2600
ALG-2	34X114	1	2800
ATL-1	34X114	1	3100

Log profiles	
Profile	Profile

34X114	
34X57	

Wall 2			
Mark	Profile	Count	Cut Length

2BL-1	34X57	1	2200
2LG-1 *	34X114	1	776
2LG-2 *	34X114	1	1547
2LG-3 *	34X114	1	2200
2LG-4	34X114	18	2200

*Gable-delivered premounted

Wall B			
Mark	Profile	Count	Cut Length

BLG-1	34X114	17	2600
BLG-2	34X114	1	2800
BTL-1	34X114	1	3100

Log profiles	
Profile	Profile

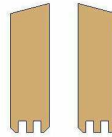
34X114	
--------	--